

# Nakamichi 582

Discrete Head Cassette Deck

Owner's Manual

## WARNING

TO PREVENT FIRE OR SHOCK HAZARD, DO NOT EXPOSE THIS APPLIANCE TO RAIN OR MOISTURE.

Please record the Model Number and Serial Number in the space provided below and retain these numbers.

Model Number and Serial Number are located on the rear panel of the unit.

Model Number : Nakamichi 582

Serial Number : \_\_\_\_\_

## CONTENTS

Controls and Features . . . . .	1
Precautions . . . . .	3
Connections . . . . .	3
Playback . . . . .	4
Recording . . . . .	5
Special Features . . . . .	7
Recommended Tape . . . . .	9
Record Calibration and Bias Adjustment . . . . .	11
The Dolby System . . . . .	13
Maintenance . . . . .	14
Troubleshooting . . . . .	16
Specifications . . . . .	rear cover

**Congratulations!**

You have chosen one of the most advanced cassette decks on the market today. The 582 is the latest in a long line of Nakamichi audio components designed and built to deliver the utmost in quality and performance. It features some of the most innovative technology in cassette deck history, such as an unusual "Discrete Head" configuration utilizing micro-precision Crystalloy record and play heads. The 582 also boasts the most efficient erase head ever devised, as well as a unique "diffused-resonance" transport controlled by C-MOS logic. Above all, the 582 is capable of taking full advantage of the latest in magnetic recording technology: the metal particle tape.

Nakamichi products are internationally famous for state-of-the-art engineering and manufacture -- your assurance that your 582 will bring you many years of trouble-free enjoyment.

At the moment, the controls and features of the 582 may be unfamiliar to you. This manual has been designed to acquaint you with the 582 in the shortest possible time. The first part of this manual will help you connect and operate your 582. The remaining sections deal with topics such as tape selection, calibration and maintenance, and may be read at your leisure. To ensure optimum results, however, we recommend you do read this manual in its entirety.

Thank you.

Nakamichi Corporation

# Controls and Features

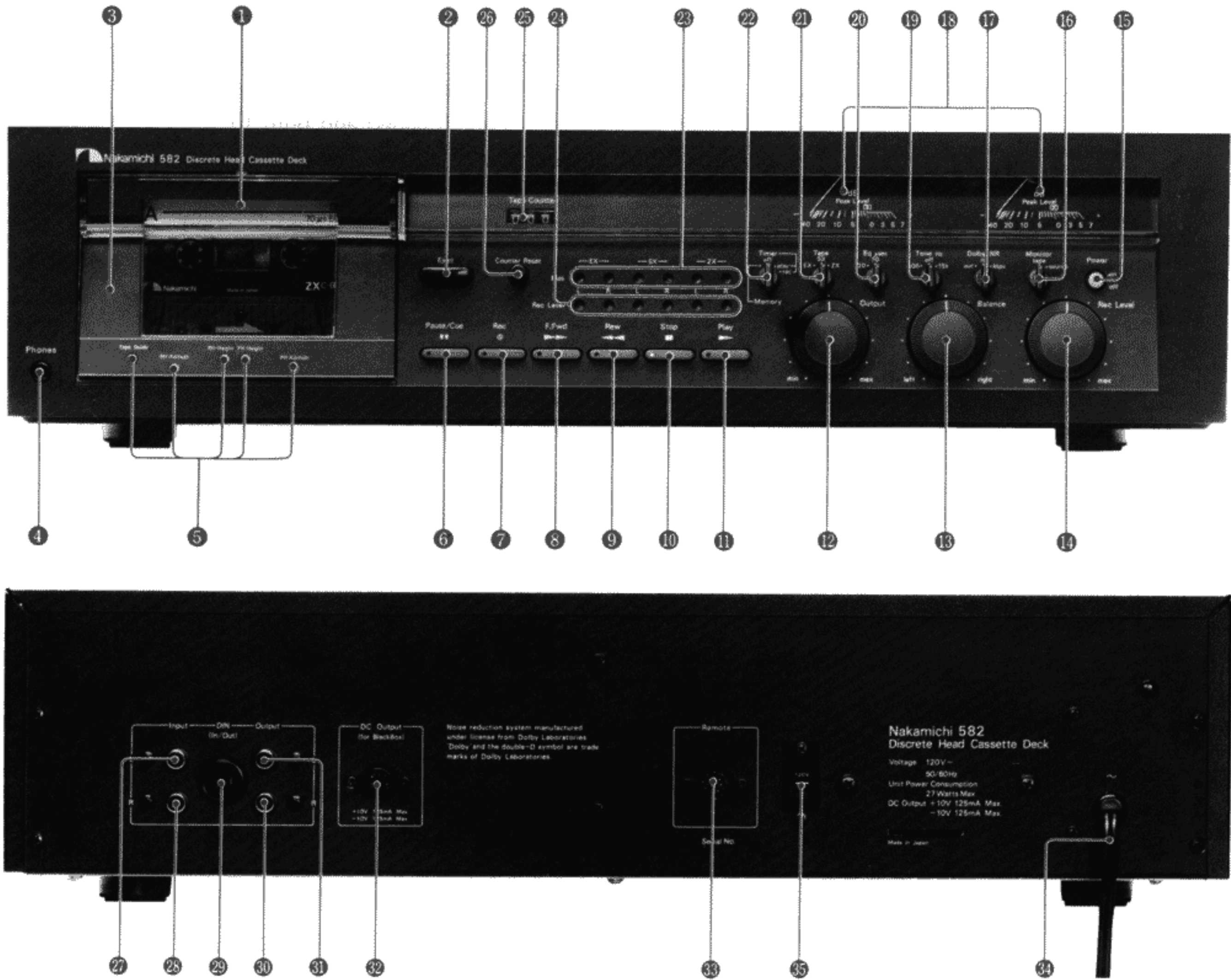

**(1) Acrylic Cassette Compartment Cover**

Can be easily detached to allow access to the heads, capstans and pressure rollers for routine maintenance. See page 14.

**(2) Eject Button**

Press to eject the cassette. The cassette lid will withdraw smoothly thanks to a built-in pneumatic damper. It is not possible to eject the cassette while the transport is in any mode other than "stop".

**(3) Cassette Lid**

Ensures proper alignment of cassette for insertion. See-thru design provides an unobstructed view of the cassette, once inserted.

**(4) Headphone Jack**

Accepts standard 1/4-inch diameter stereo phone plug.

**(5) Head Height and Azimuth Alignment Screws**

These adjustments have been calibrated at the factory for optimum performance. **DO NOT ATTEMPT RE-ADJUSTMENT.** These adjustments should only be made by qualified service technicians.

**(6) Pause/Cue Button**

Used for noise-free stopping of the tape in the record mode. Also halts tape motion in the play

mode. Allows cueing in the rewind and fast-forward modes. See page 7.

#### (7) Record Button

Puts the 582 into the record mode. See page 5.

#### (8) Fast-Forward Button

Moves tape rapidly in the forward direction.

#### (9) Rewind Button

Moves tape rapidly in the reverse direction.

#### (10) Stop Button

Stops the transport from fast-forward, rewind, record or play when pressed. This is the only mode in which the head assembly is fully retracted.

#### (11) Play Button

Starts the transport motion forward at the standard 1-7/8 inches per second for record and playback.

#### (12) Output Level Control

Controls the output level of the 582 during record and playback. Has no effect on record levels. In the maximum (fully clockwise) position the output for each channel will be 1 V at a meter reading of 0 dB.

#### (13) Balance Control

Controls the relative balance between the left and right inputs. Has no effect on playback levels.

#### (14) Input Level Control

Controls the input (record) levels for the left and right channels simultaneously.

#### (15) Power Switch

Activates the 582. The level meters and cassette compartment will illuminate to indicate that power is "on".

#### (16) Monitor Switch

Selects either the input signal ("source") or the playback signal ("tape") for monitoring during record. Must be in "tape" position for playback.

#### (17) Dolby NR/MPX Filter Switch

Activates Dolby Noise Reduction circuitry, which reduces tape hiss by as much as 10 dB when used during record and playback. In the "MPX" position, this switch engages a filter in addition to the Dolby circuit in order to attenuate the 19 KHz multiplex carrier signal present in FM stereo broadcasts. This carrier can "fool" the Dolby system. The "MPX" position should be used only when recording FM stereo broadcasts.

#### (18) Peak Level Meters

Indicate peak program levels from -40 to +7 dB. "0 dB" on Nakamichi decks corresponds to "Dolby Level" which is defined as a tape fluxivity of 200 nanowebers per meter.

#### (19) Test Tone Switch

Selects and activates one of two built-in test tone oscillators: 400 Hz @ 0 dB, or 15 KHz @ -20 dB. The former is used for record calibration and the latter for bias adjustment. See page 11.

#### (20) Eq Switch

Selects either 120 or 70 microsecond equalization. Proper record and playback equalizations ensure optimum performance with each tape type. See page 9 for a detailed explanation.

#### (21) Tape Switch

Selects required record sensitivity and bias level for three different tape types: EX (low-noise/high-output ferric oxide), SX (chrome-equivalent), and ZX (metalloy).

#### (22) Tape Start Memory/Timer Switch

The "Memory" position enables the deck to "remember" any starting point on the tape. Set the tape counter to 000 at the desired point, and the 582 will automatically stop from the rewind mode when the counter reaches 999. The "Timer" positions are used for unattended recording or playback at a pre-selected time. An external timer is required for the latter feature. See page 7.

#### (23) Bias Adjustment Controls

Screwdriver adjustments for record bias current. Bias adjustments can be performed using the 582's built-in 15 KHz test tone. See page 12.

#### (24) Record Calibration Controls

Screwdriver adjustments for record level calibration, essential for proper tracking of the Dolby Noise Reduction circuits. These controls are adjusted using the built-in 400 Hz test tone. See page 11.

#### (25) Tape Counter

Indicates relative position of the tape. May be used to index selections on the tape.

#### (26) Counter Reset Button

Resets the tape counter to 000 when fully depressed.

#### (27) Left Input Jack

#### (28) Right Input Jack

#### (29) DIN In/Out Connector

#### (30) Right Output Jack

#### (31) Left Output Jack

#### (32) DC Output Jack

Provides a regulated  $\pm 10$  Volts DC to power one or more of Nakamichi's BlackBox Series components, such as the MX-100 Microphone Mixer. Total current consumption of BlackBox components powered from this jack must not exceed 125 mA. See page 8.

#### (33) Remote Control Socket

The optional RM-580 Wireless Remote Control receptor unit is plugged into this socket. This socket also accepts the RM-10 Remote Control, which is supplied with a 5-meter (15 ft.) cable.

#### (34) Power Cord

#### (35) Voltage Selector

AC Voltage is factory set for the country in which the 582 is sold. Voltage selector permits re-setting of mains voltage in case deck is to be used in a different country.

Note:

Safety regulations in certain countries prohibit inclusion of a voltage selector.

This feature, therefore, may be absent from your deck.

# Precautions

1. Do not install the 582 close to heat sources (such as radiators), or in a place subject to direct sunlight, excessive dust or moisture.
2. Make sure the memory/timer switch (22) is set to "off" or "Memory" when you do not desire the self-starting feature. Should this switch be accidentally left in the "rec" position, you will begin recording merely by turning on the power switch. A cassette tape already in the compartment and without its protective tabs removed will be erased in such instances. Although this may be an unlikely occurrence, you can eliminate the possibility of such accidental erasure by observing this precaution.
3. Make sure the test tone switch (19) is set to "off" (center position) for normal recording or playback. The test tone oscillator overrides the input to the 582 during record, and in the "15 KHz" position there is a shift in meter range, making playback readings inaccurate.
4. The 582's head assembly is at the bottom of the cassette compartment. The cassette, therefore, must be inserted with the exposed tape down. (Nakamichi 1000 owners note!) Inserting the cassette upside down, and then forcing the lid shut may cause serious damage to the cassette and the 582.

# Connections

There are two ways of connecting the Nakamichi 582 to your preamplifier, amplifier or receiver. You may use shielded cables with RCA plugs (provided with the deck) to connect the left and right input jacks (27, 28) to the "rec" or "tape out" jacks on your preamplifier. In the same way, connect the output jacks (30, 31) to the "tape in", "tape mon",

"tape PB" or "aux in" jacks of your preamplifier.

If your preamplifier or receiver is equipped with a DIN socket, you may use a DIN in/out jack of the 582 (29) to the similar jack on your preamplifier. (In this case, do not use RCA cables simultaneously.)

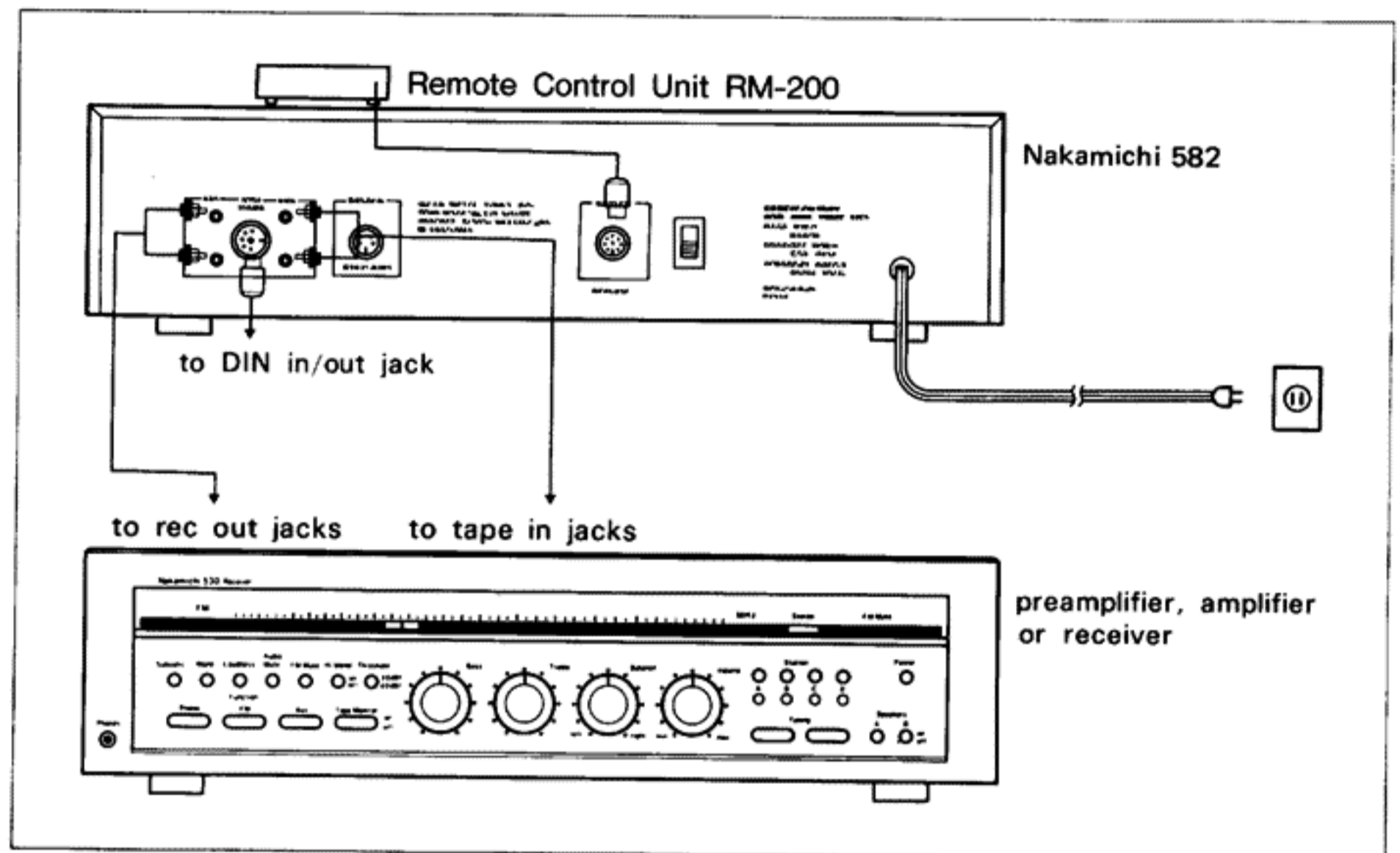

## Headphones

Standard stereo headphones may be connected to the headphone jack (4) on the 582's front panel. Low impedance headphones (8 ohms nominal) are recommended.

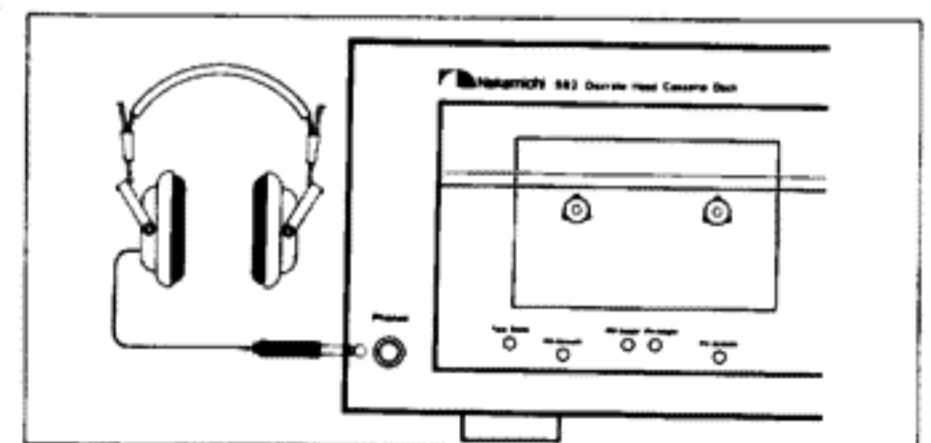

## DC Output Jack

The DC output jack (32) on the rear panel of the 582 provides a regulated  $\pm 10$  Volts DC supply expressly for the purpose of powering one or more of Nakamichi's BlackBox Series components. Use the DC power cord supplied with each BlackBox unit to connect the DC output jack of the 582 to the DC input jack of the BlackBox unit. See the section entitled "Special Features" (page 8) for more information on the BlackBox Series.

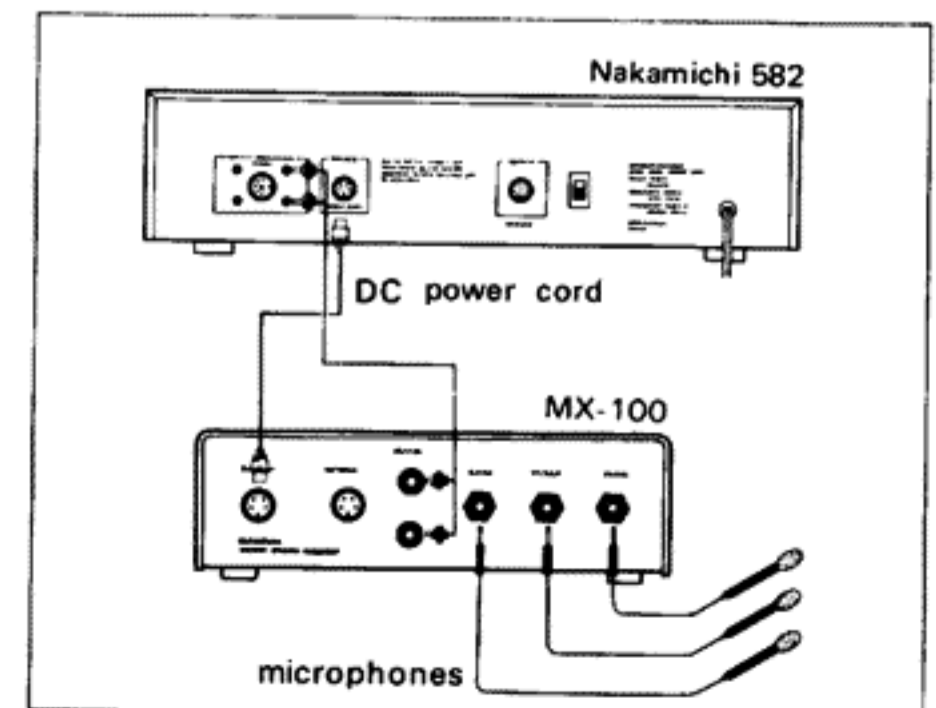

# Playback

- (A) Turn the power switch (15) "on" (depress). The cassette compartment and peak level meters will illuminate to indicate power.
- (B) Take a pencil or pen with hexagonal cross-section (or a finger) and gently tighten any loose tape onto the supply reel of the cassette. Loose tape, especially where the tape is exposed, may prevent proper contact with the capstans and pressure rollers.
- (C) Open the cassette compartment lid (3) by pushing the eject button (2).
- (D) Load the cassette into the lid from the top. Make sure the exposed tape is facing down and the label of the desired side is facing you. (See photo.) Close the cassette lid (3) by pushing it gently back into the panel.



- (E) Set the Eq switch (20) to the required position – either 120 or 70 microseconds. See page 9 for details. The tape selector switch (21) has no effect on playback.
- (F) If the tape was recorded with the Dolby system, set the Dolby NR switch (17) to its "in" (depressed) position.
- (G) Set the monitor switch (16) to the "tape" position.
- (H) Press the play button (11) to start the tape.
- (I) To stop the tape momentarily, press the pause/cue button (6). To resume playback, press the play button (11) again.
- (J) To stop the tape altogether, press the stop button (10). After the tape has stopped, you may eject it by pushing the eject button (2).

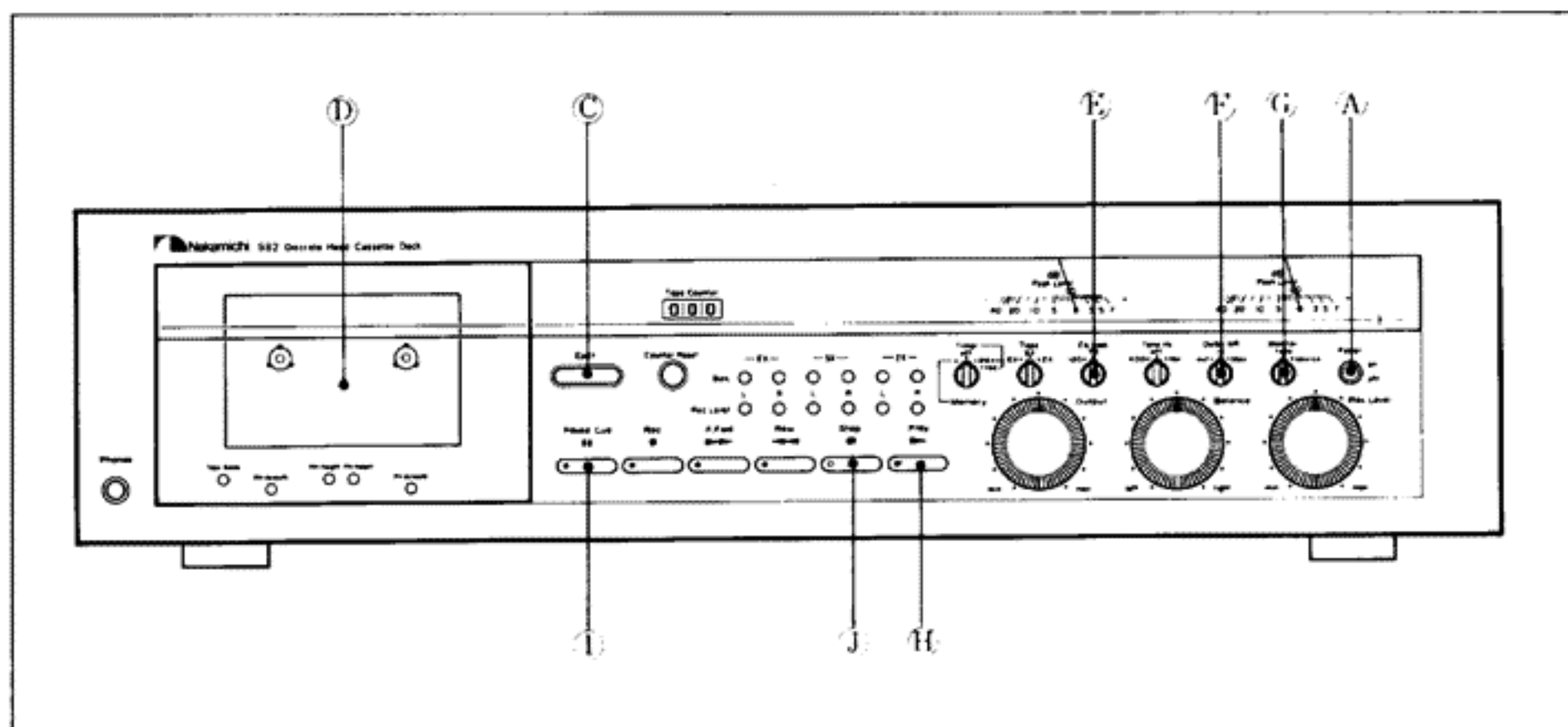

## Note:

- You cannot eject the cassette while the tape is in motion.
- When the tape reaches its end, or if a defect within the cassette impedes tape motion, the 582's logic circuitry will return the transport to the stop mode automatically.
- Logic circuitry prevents operation of the transport when the cassette lid is open.
- You need not press the stop button when going from one transport mode to another (for example, from rewind to fast-forward).
- During playback, the peak level meters (18) indicate the levels of the signals recorded on the tape. The output level control (12) will affect volume, but it will have no effect on meter readings.
- If you find the meter readings excessively high, you probably have the test tone switch (19) set to "15 KHz". It should be "off".
- It is possible to "cue up" a selection on the tape using the 582's unique cueing feature. See the section on "Special Features" (page 7) for instructions.

# Recording

- (A) Turn the power switch (15) "on" (depress). The cassette compartment and peak level meters will illuminate to indicate power.
- (B) Take a pencil or pen with hexagonal cross-section (or a finger) and gently tighten any loose tape onto the supply reel of the cassette. The tape should be snug for proper contact with the capstans and pressure rollers.
- (C) Open the cassette compartment lid (3) by pushing the eject button (2).
- (D) Load the cassette into the lid from the top. Make sure the exposed tape is facing down and the label of the desired side is facing you. Close the cassette lid (3) by pushing it gently back into the panel.
- (E) Set the Eq and tape selector switches (20, 21) as required. See page 9 for details. If you are using an unfamiliar brand of tape, we recommend that you check the record level calibration before proceeding any further (see page 11 for calibration procedure).
- (F) Set the Dolby NR switch (17) "in" for low-noise recording. Because Dolby decoding will be required for proper playback, be sure to make a note on the cassette label that the tape is Dolby-encoded.
- (G) If your program source is FM stereo, set the Dolby NR switch (17) to "Mpx". Leakage of the 19 KHz multiplex carrier from your tuner may otherwise cause erratic behavior of the Dolby circuits.
- (H) Press the tape counter reset button (26). The tape counter (25) should now read 000.
- (I) Press the play button (11) and allow the tape to run to a count of 003. Then, press the stop button (10). The first few inches of tape have slight surface irregularities imprinted by the spool and the leader tape splice. For this reason, it is best not

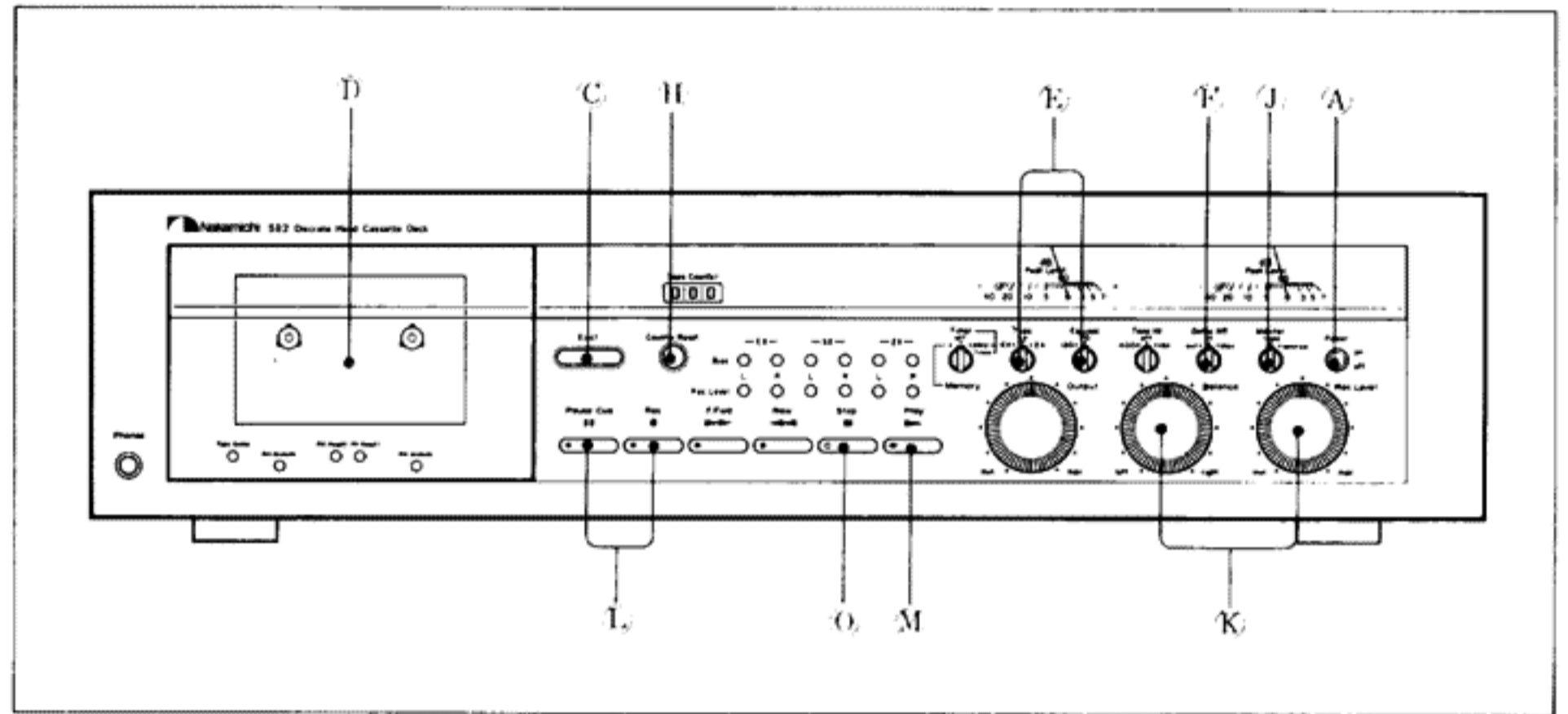

- to record from the very beginning of the tape.
- (J) Set the monitor switch (16) to "source".
- (K) You are now ready to set the input (record) levels. Use the input level control (14) while playing a portion of your program source to obtain readings on the peak level meter. The balance control (13) is normally left in its center-detent position, but it may be used to correct imbalance of input levels. See the section entitled "Tips on Setting Record Levels" (page 6) for more detailed information on this procedure.
- (L) To put the 582 into the record/stand-by mode, press and hold the record button (7) with one finger; while holding this button, press the pause/cue button (6). The red lamp above the record button will light to indicate record mode.
- (M) To commence recording once levels are set, simply press the play button (11).
- (N) To halt recording temporarily, press the pause/cue button (6). Press the play button (11) again when you are ready to resume recording.
- (O) To stop recording altogether, push the stop button (10). When you have completed recording an FM stereo

- broadcast, remember to return the Dolby NR/Mpx filter switch (17) to its normal position.
- (P) If you wish to check the quality of a recording in progress, you can monitor the playback signal by setting the monitor switch (16) to "tape".



## Cassette Tabs

You can protect valuable recordings from accidental erasure and re-recording by completely removing the appropriate tab on the top edge of the cassette. The tab for each side is located on the top-left-hand corner as you face the side. Use a small screwdriver, and push the tab down to break it off. Do not leave the broken tab in the recess. If you wish at a later date to record over a side for which the tab has been removed, cover the tab opening with a piece of adhesive tape.



## Tips on Setting Record Levels

The proper setting of record levels requires practice and patience. Setting the level too high will result in tape saturation, which is audible as a grossly distorted recording. Low recording levels result in unacceptably noisy recordings because there is not enough of the signal on the tape to overcome the "hiss". Record level indicators vary in their effectiveness, but even the best indicator system is not totally foolproof. It takes experience to know just how much signal one can put on the tape. The best setting will be determined by the type of tape in use, the type of source material to be recorded and, to some degree, personal preferences of the user (some are willing to sacrifice signal-to-noise ratio to ensure distortion-free recording while others are willing to tolerate occasional tape saturation for quieter recordings).

The fast-acting peak-level meters of the Nakamichi 582 are more accurate than the so-called VU meters found on most cassette decks. Conventional meters are not fast enough to give accurate indications of musical peaks. The illustration below shows that there can be as much as 18dB difference between a peak-reading meter and a conventional meter on a transient signal, even though the two meters give the same reading on a continuous signal.

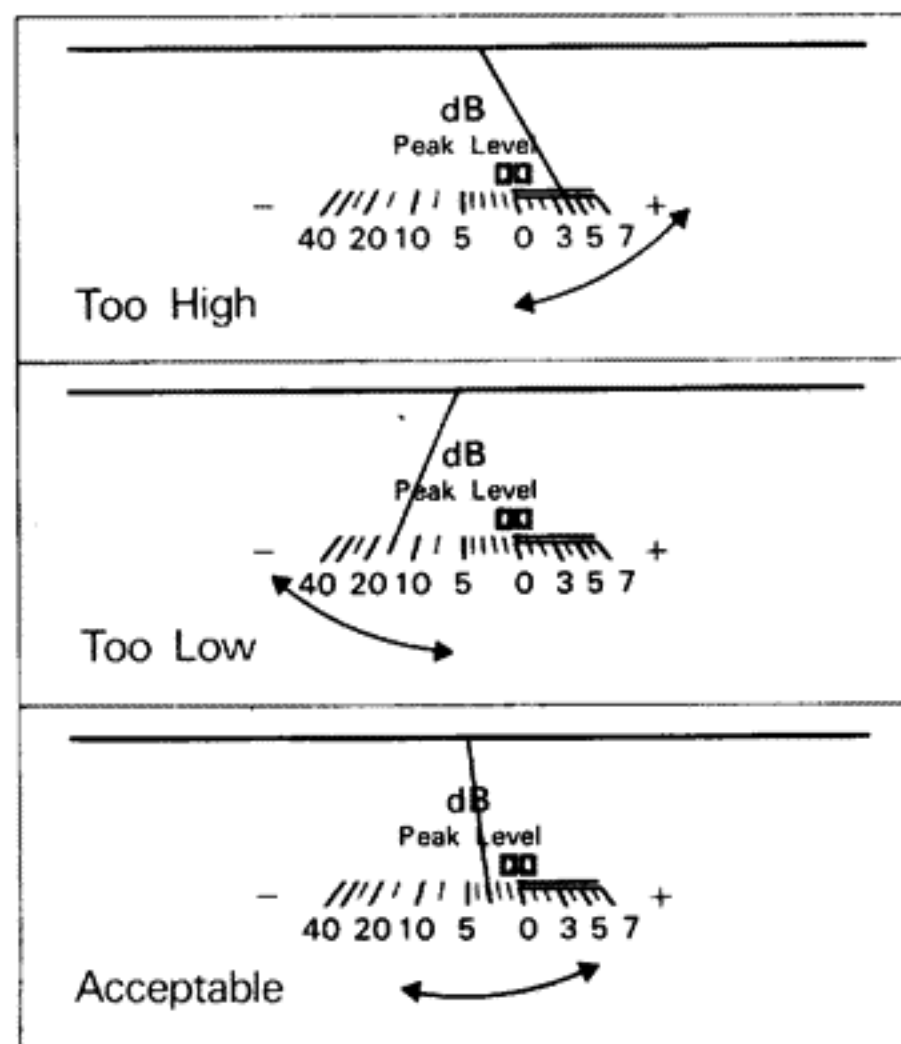

As a guide, begin by setting the record levels so that the meters occasionally "peak" into the red region above 0 dB on a loud portion of the signal source. Brief excursions as high as +5 to +6 dB generally do not result in noticeable saturation. If the needles stay above 0 dB for long periods, however, you are almost certainly producing an unacceptably distorted recording. You can, of course, check whether the levels have been correctly set by making a brief sample recording of the loudest passages and listening carefully while playing it back. This is only possible, however, if your source is pre-recorded material, such as an LP record or another tape.

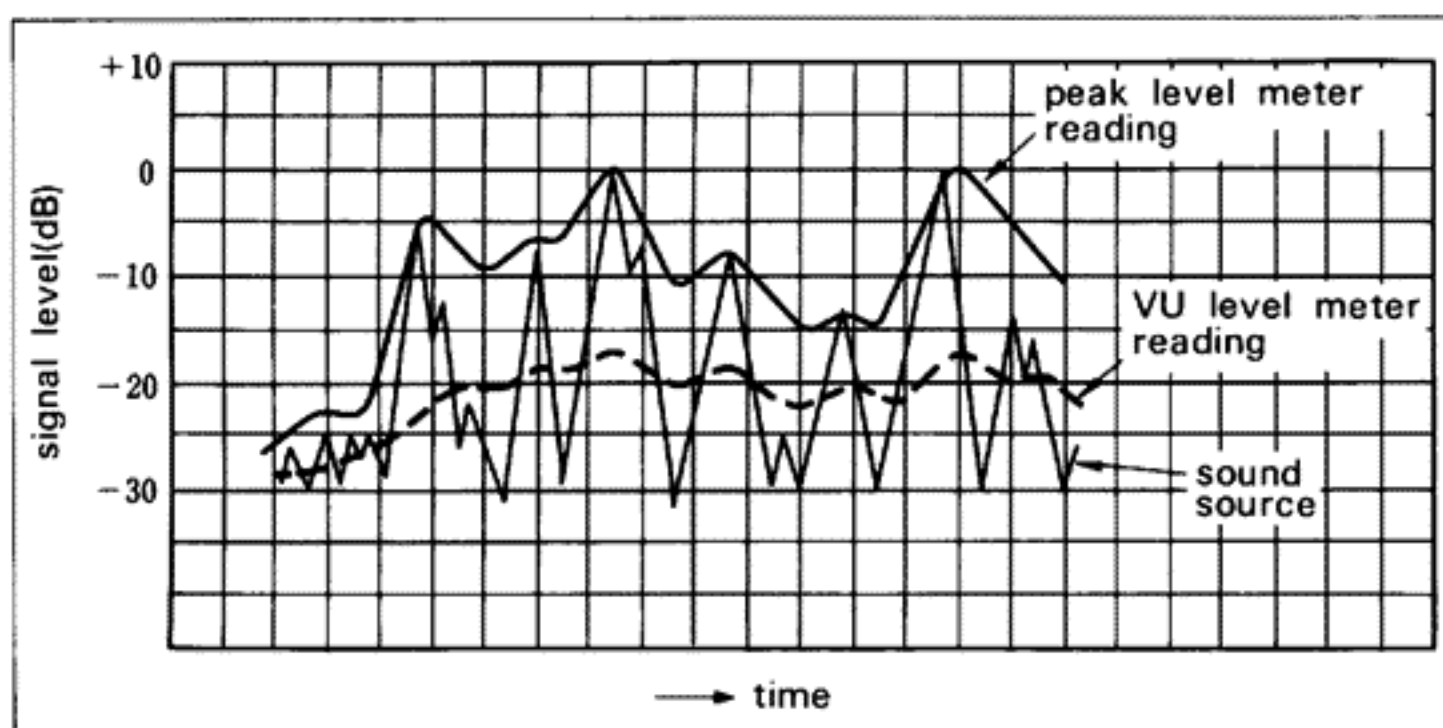

## Recording on Metalloy Tape

The Nakamichi 582 is one of the first cassette decks on the market with the ability to take advantage of the latest development in magnetic recording: the metal particle or metal alloy (metalloy) tape. Metalloy cassette formulations are capable of storing several times the magnetic energy encountered on the best of conventional oxide tapes. The 582 provides radically new erase and record head designs which are capable of handling the increased bias requirement of metalloy. In practice, metalloy tapes offer 3–4 dB additional headroom at midrange frequencies and 8–12 dB improvement at higher frequencies when compared to chrome-equivalent cassettes. Metalloy also provides reduced harmonic distortion and noise when used with an advanced deck like the 582. You will find that metalloy tapes can be "pushed" a little further than conventional tapes; in other words, you can record at slightly higher levels with metalloy tape than you can with conventional tape.

Most users will find the performance of the 582 with conventional tapes more than satisfactory for their applications. The added capabilities of metalloy is best reserved for special applications, such as live recording or copying from studio-quality "master" tapes.

# Special Features

## Tape Start Memory

The memory switch (22) and the tape counter (25) work in conjunction to provide a handy method of re-locating any starting point on the tape. Whether you are recording or playing back, press the counter reset button (26) at any point on the tape if you think you will want to return to that point. By pressing the counter reset button, you will ensure that the tape counter will begin from 000. Later in the tape, when you want to return to your starting point, simply set the memory/timer switch (22) to "memory" and press the rewind button (9). The transport will automatically stop at a counter reading of 999.

## Timer Operation

The 582 has a built-in self-start feature which enables you to make unattended recordings. This feature can also be used to have the 582 begin playing a cassette at a pre-selected time of day. To take advantage of this feature, you must use a timer, such as the Nakamichi DS-200 Digital Program Timer. An ordinary appliance timer can also be used, although this type of timer generally does not allow you to precisely set starting time.

Plug the AC power cord of the 582 into an AC outlet on the timer. Any other component which is to be turned on at the same time as the 582, such as a tuner or receiver, must also be plugged into the timer. If the timer provides only one outlet, use it for the tuner or receiver, and plug the 582's power cord into one of the outlets on the rear of the tuner or receiver. With the system's power "on" load a cassette into the 582, and make all necessary level adjustments (input levels for unattended recording, volume levels for automatic playback). Then, set the timer for the desired starting time. Make sure all the necessary power switches are "on".

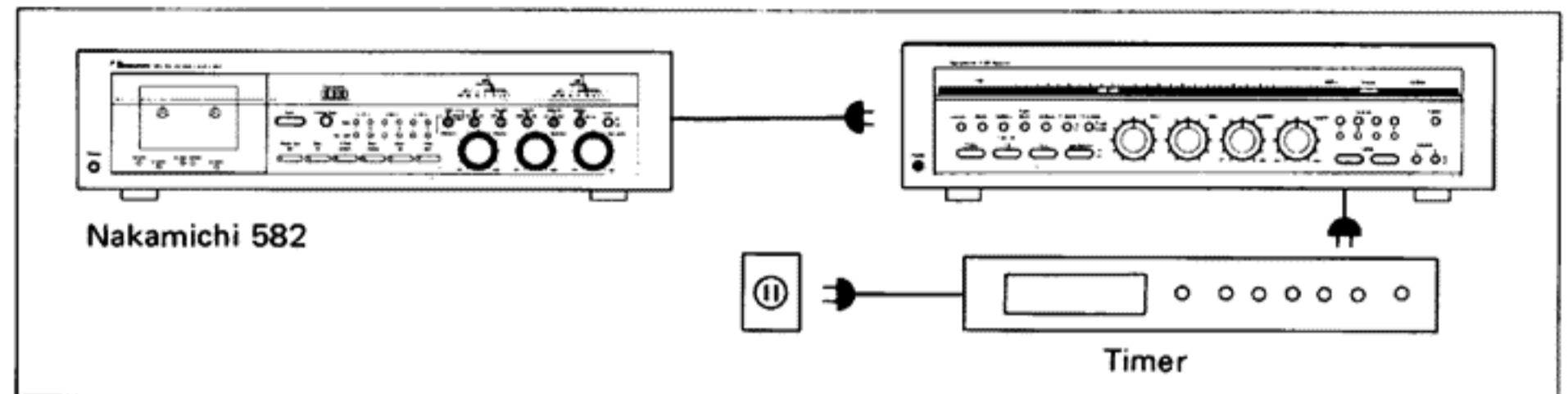

Set the memory/timer switch (22) to the "play" or "rec" position, depending on whether you desire unattended playback or record, respectively. At the pre-selected time of day, the timer will turn on your system, and the 582 will begin playing or recording.

Make sure you return the memory/timer switch to its "off" position when you have finished using the self-start feature. In particular, take care not to leave this switch in the "rec" position. You may, otherwise, inadvertently erase a cassette left in the 582 the next time you turn on your system.

## Cueing

When the tape is shuttling during rewind or fast-forward, the head assembly is normally retracted and the output muted so that you do not hear the unwanted, high-pitched sounds that would otherwise result. But these high-pitched signals, if somewhat reduced in speed, can be used to locate the blank spots which mark the end of one selection and the beginning of the next. Most professional, open-reel tape decks offer just such a feature. It is called cueing.

The 582 provides a unique feature quite similar to cueing systems found on professional equipment. While you are in rewind or fast-forward, you can hear the tape in high-speed motion by pressing the pause/cue button (6). Pressing this button while the deck is fast-winding will move the playback head closer to the tape and reduce winding speed to one-third. You

can further reduce winding speed (to approximately one-fifth) by pressing the rewind or fast-forward button (9, 8) after you have first pressed the pause/cue button. You will remain in cueing mode until you press the stop button (10) or the play button (11).

## Remote Control

It is possible to operate the Nakamichi 582 from a remote location by using RM-200.

The RM-200 is remote control system which enables operation of the 582 from a distance of 5 meters (approx. 15 ft.). The cable from the remote control unit plugs directly into the 582's remote control socket (33).

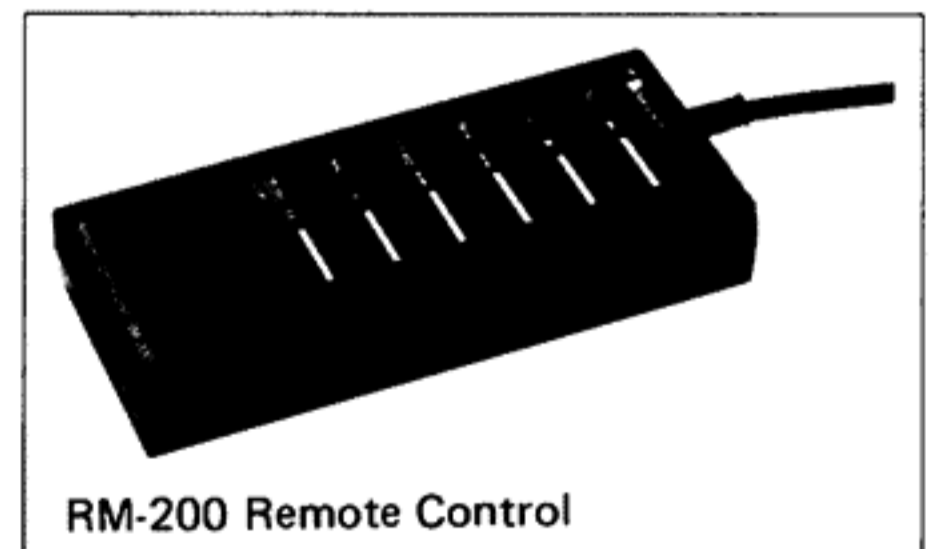

RM-200 Remote Control

## Nakamichi BlackBox Series Components

The 582 provides a rear panel connector which can be used to power one or more of Nakamichi's BlackBox Series accessories. The DC output jack (32) supplies a regulated  $\pm 10$  Volts DC and thus eliminates the need for the separate PS-100 Power Supply, which is normally used to power the BlackBox components. Although this jack can be used to power any Nakamichi BlackBox component, the following three have the greatest potential application for the 582.

### MX-100 Microphone Mixer

Since the 582 has no built-in microphone preamplifiers, an external microphone mixer must be used for "live" recordings. The MX-100 provides three mic inputs (left, right and center "blend") with low noise and unusually wide dynamic range. It is particularly well-suited for applications of Nakamichi's tri-microphone live recording system. Nakamichi publishes a booklet on live recording, available on request, for those who wish to pursue the subject in further detail.

### SF-100 Subsonic Filter

If your preamplifier does not include a subsonic filter for the phono stage, you may occasionally experience a "fluttering" effect when recording warped records. If your turntable has excessive rumble, you may experience this effect rather frequently. Although it is best to prevent subsonic signals at their source, a good filter can "clean up" the sound considerably. The extended low frequency performance of the 582 makes it especially important that the input signal be free of extraneous subsonics. Lacking a subsonic filter in your preamplifier, you can add a Nakamichi SF-100 at the input of the 582.

### LA-100 Line Amplifier

Although the 582 was designed to accommodate a wide range of amplifier input/output sensitivities, certain combinations may result in a mismatch. You may find the record output from your amplifier or receiver insufficient. Or your amplifier's tape input may lack sufficient sensitivity, making it difficult to achieve satisfying playback levels. The Nakamichi LA-100 can cure these and other mismatch problems.

The table below gives the maximum current consumption ratings for each of the BlackBox components. Refer to this table to calculate which and how many BlackBox units can be powered by the 582. Under no circumstances connect BlackBox units exceeding 125 mA in total current consumption. If you wish to use multiple BlackBox components which exceed 125 mA in total current consumption, please purchase a PS-100 Power Supply. The instruction booklets supplied with individual BlackBox Series components should be consulted for additional information.

BlackBox Component	Current Rating
SF-100 Subsonic Filter	25 mA
LA-100 Line Amplifier	50 mA
BA-150 Bridging Adaptor	25 mA
MB-150 MC Booster Amp	100 mA
EC-100 Electronic Crossover	100 mA
MX-100 Microphone Mixer	50 mA

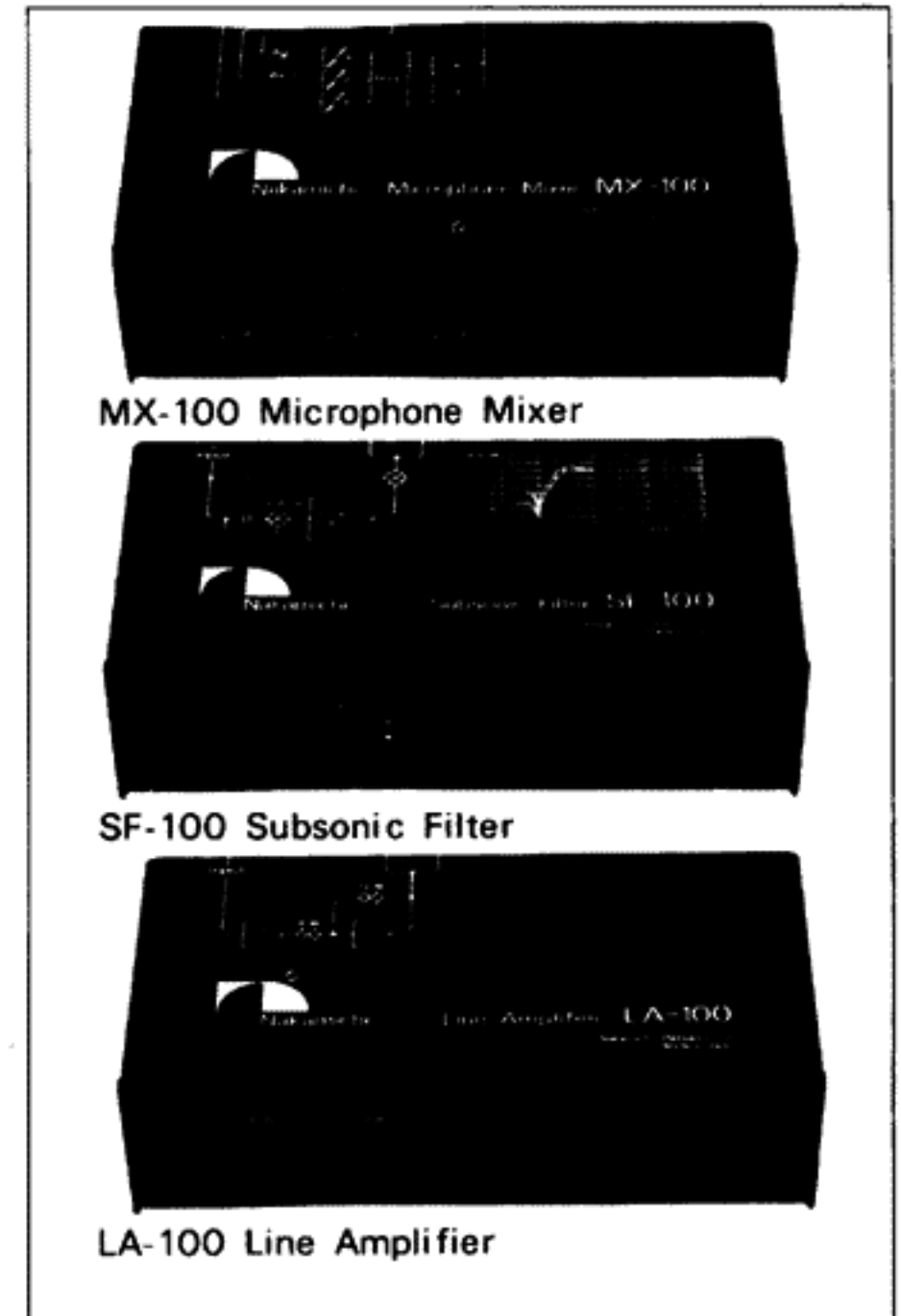

# Recommended Tape

Choosing a high quality recording tape is extremely important. A sophisticated cassette deck, like the 582, cannot be expected to deliver superior performance with inferior tapes. The numerous brands and types of blank cassettes on the market vary not only in the consistency of the tape coating, but in the degree of mechanical precision as well. The performance of an otherwise excellent tape is often marred by a poor housing, which can result in skewing and other unsteady tape travel conditions.

Nakamichi offers several premium quality cassettes manufactured to the strictest tolerances. These cassettes are used at the Nakamichi factory for final adjustments to the decks. Nakamichi cassettes are what enable Nakamichi to guarantee cassette deck specifications. In addition to offering these reference-grade cassettes, Nakamichi maintains a sampling program to evaluate the performance of the market's most



popular cassettes. The table below lists those cassette tapes which are acceptable by Nakamichi's standards. Brands other than Nakamichi are listed in alphabetical order. Since this list is subject to constant updating, we recommend you periodically write to Nakamichi to obtain the most recent test results. Nakamichi does not recommend the use of C-120 or ferrichrome cassettes under any circumstances.

## Tape and Eq Switch Settings

The Tape and Eq selector switches on the 582 permit you to choose from a variety of tape formulations. The Tape switch selects the proper bias and record sensitivity for each cassette type. The Eq switch gives you a choice of record and playback equalizations to optimize conditions for the type of tape in use and the nature of the program material to be recorded.

Bias is an inaudible high frequency signal used to reduce the non-linearities and distortions inherent in the magnetic recording process. Bias is applied only during record, and, hence, the Tape selector has no effect during playback. Low-noise/high-output ferric oxide (or modified ferric oxide) formulations, like Nakamichi EX-II require a certain bias level, sometimes termed "normal". Chromium dioxide and chrome-equivalent tapes, such as Nakamichi SX, require approximately 45% more bias. Metal tape formulations, such as Nakamichi ZX, require almost twice the bias of chrome-equivalents for distortion-free recording. Your Nakamichi 582 has been factory adjusted for Nakamichi EX-II, SX and ZX tapes in each of the respectively marked Tape switch (21) positions. The other recommended tapes are closely compatible in their respective categories. On page 12 of this manual, you will find a detailed procedure for fine-tuning the bias for optimum recording with each tape formulation.

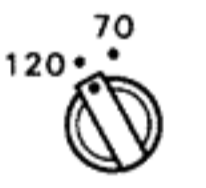
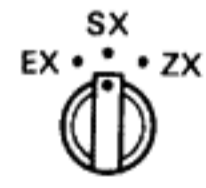
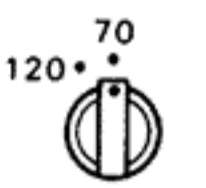
Equalization is used in record and playback to achieve optimum signal-to-noise and headroom performance for different tape formulations. Like bias, the proper Eq switch (20) setting must be selected for each type of tape. Unlike bias, the Eq switch must be set for both record and playback. Normally, you would set the Eq switch according to the table, but the excellent high frequency

Tape Switch Setting	Recommended Eq Setting	Brand	Formulations
 ("normal" bias)	 120 μsec	Nakamichi Ampex Fuji Maxell TDK	EX, EX-II Grand Master I FX-I UD, UDXL-I D, OD
 ("chrome" bias)	 70 μsec	Nakamichi Ampex Fuji Maxell TDK	SX Grand Master II FX-II UDXL-II SA
 ("metal" bias)	 70 μsec	Nakamichi Others*	ZX

\*Most major tape manufacturers will be offering a metal formulation in 1979. Lack of specific test data prevents listing by brand at this writing. Write to Nakamichi for up-to-date information regarding metalloy cassettes.

performance of the Nakamichi 582 permits unusual settings of the Eq switch for special purposes:

- (A) If you wish to make a recording on SX-type or ZX-type for someone who does not have 70  $\mu$ sec equalization (sometimes labeled the "CrO<sub>2</sub>" or "chrome" position) on his cassette deck, record with the Tape switch (21) in the recommended position but the Eq switch (20) in the 120  $\mu$ sec position.
- (B) Occasionally, you may encounter program material with an unusually high amount of energy at higher frequencies. (Some synthesizer music fall into this category.) In such instances you may wish to record on SX-type or ZX-type tape with the Eq switch (20) in the 120  $\mu$ sec position rather than the recommended 70  $\mu$ sec position. This will result in 3–4 dB higher noise, but high-frequency saturation will be commensurately reduced. Be sure to make note of the special equalization on the cassette label and to play back with the 120  $\mu$ sec equalization.
- (C) Some program material may make large dynamic range demands at mid-frequencies but with comparatively little high-frequency content. In such instances you can take advantage of the 70  $\mu$ sec equalization, even with an EX-type tape, which normally uses 120  $\mu$ sec. If you record on an EX-type tape with the 70  $\mu$ sec Eq, you will be giving up a certain amount of high-frequency overload margin but gaining 3–4 dB of signal-to-noise ratio. As above, make note of the special equalization and be sure to play the cassette with the 70  $\mu$ sec Eq setting.

# Record Calibration and Bias Adjustment

The various tapes listed on page 9 are approximately compatible in their respective categories. It is best, nevertheless, to choose one specific formulation for each of the three tape positions and use these three consistently. By doing so, you need not worry about the compatibility of a new and different kind of tape, and you will gain familiarity and confidence in recording which cannot be gained if you are constantly changing brands. But even the best of tape manufacturers will often change the characteristics of their products without notice. You may, furthermore, want to experiment with a different brand from time to time. It is recommended, therefore, that you periodically check record calibration and bias.

Record level calibration can be easily performed on the 582 without the use of any external test instruments. Proper level calibration is essential for accurate tracking of the Dolby noise reduction circuits. The procedure described in this section is simple to follow; and once you gain familiarity with this calibration, it will take you less than a minute to perform.

Bias adjustment is usually left to qualified service personnel. But the 15 KHz test tone system incorporated in the 582 makes it possible for the user to perform his own bias re-adjustments. In general, bias adjustment is required only if your recordings sound "dull" or "bright" in comparison to the original program source. If you suspect bias misadjustment, follow the procedure outlined later in this section.

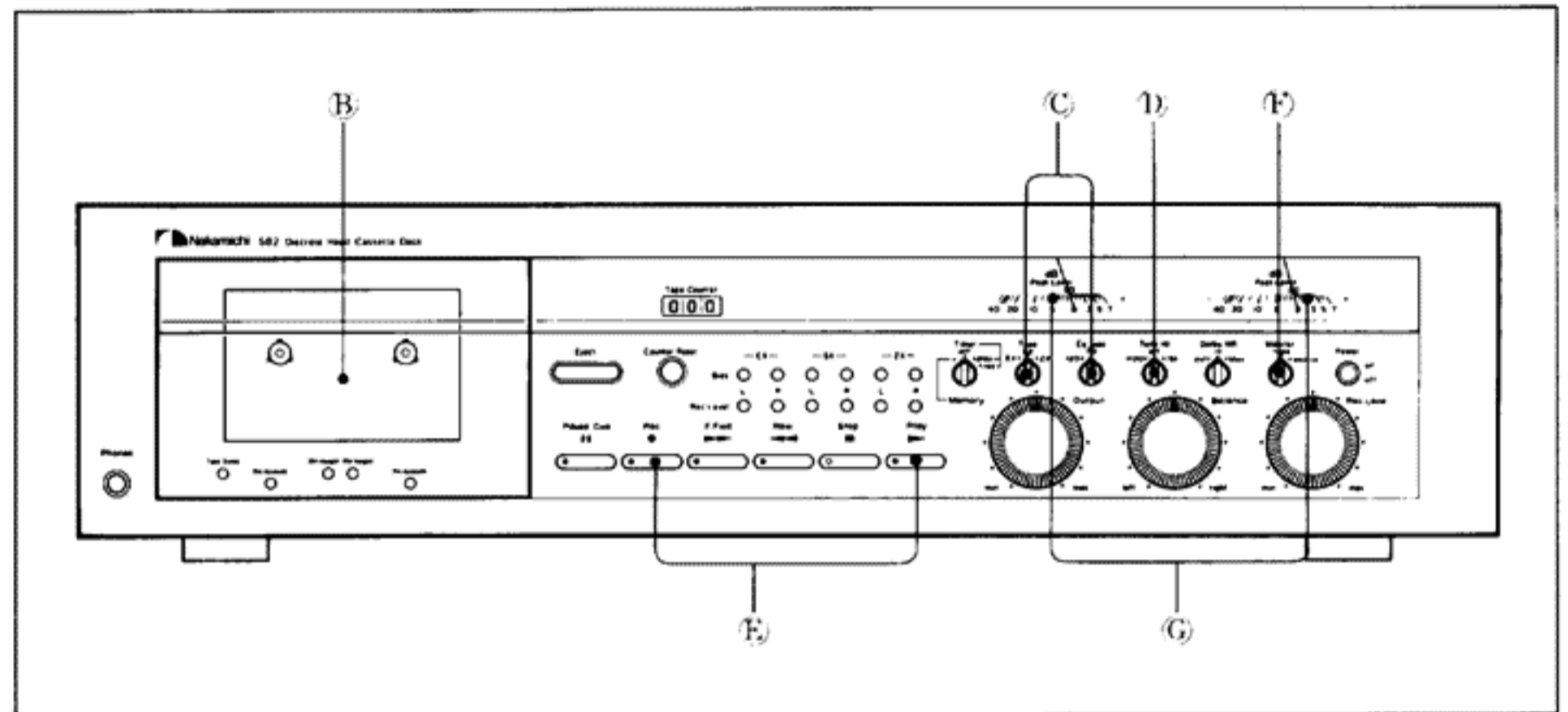

## Record Calibration

- (A) Take a few moments to familiarize yourself with the location and layout of the "rec cal" screwdriver controls (24) on the front panel of the 582. Note that there are separate controls for each of the three tape positions and for each channel (left and right).
- (B) Load the desired cassette and fast-forward for several seconds before stopping.
- (C) Set the Tape and Eq switches (21, 20) according to the type of tape in use. See page 9 for recommended settings.
- (D) Set the test tone switch (19) to "400 Hz". This will activate the built-in 400 Hz oscillator, which now overrides any external input to the 582. With the monitor switch (16) in the "source" position, the peak level meters should both indicate "0 dB".

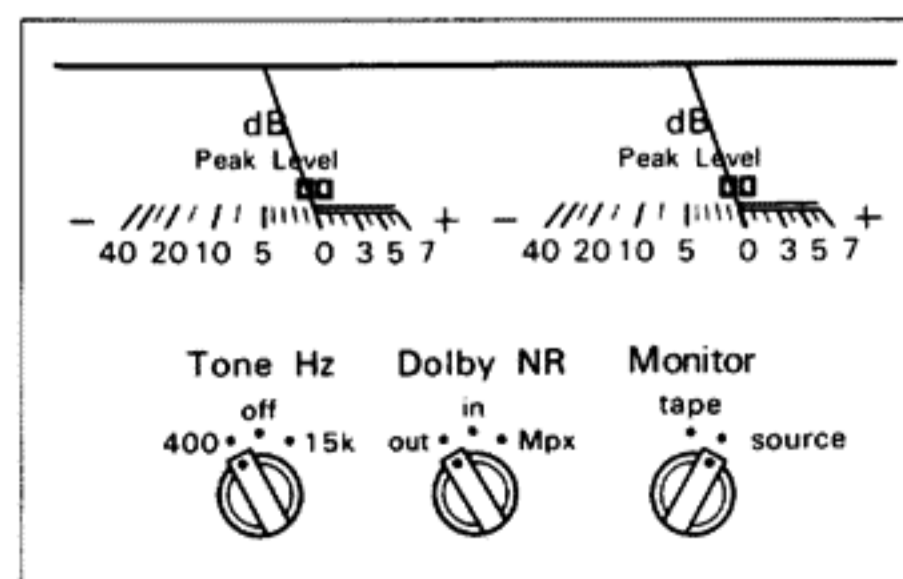

- (E) Begin recording the 400 Hz test tone by pressing the record and play buttons (7, 11) simultaneously.
- (F) Set the monitor switch (16) to "tape". The meters are now indicating the playback level of the test tone. If both meters register within one dB of the "0 dB" mark, there is no need to perform further calibration.
- (G) If the meters do not indicate 0 dB level, make adjustments to the appropriate rec cal controls (24) using the small screwdriver supplied with the deck. Turn clockwise to correct a low reading. Turn counter-clockwise to correct a high reading.
- (H) Return the test tone switch (19) to the "off" position.

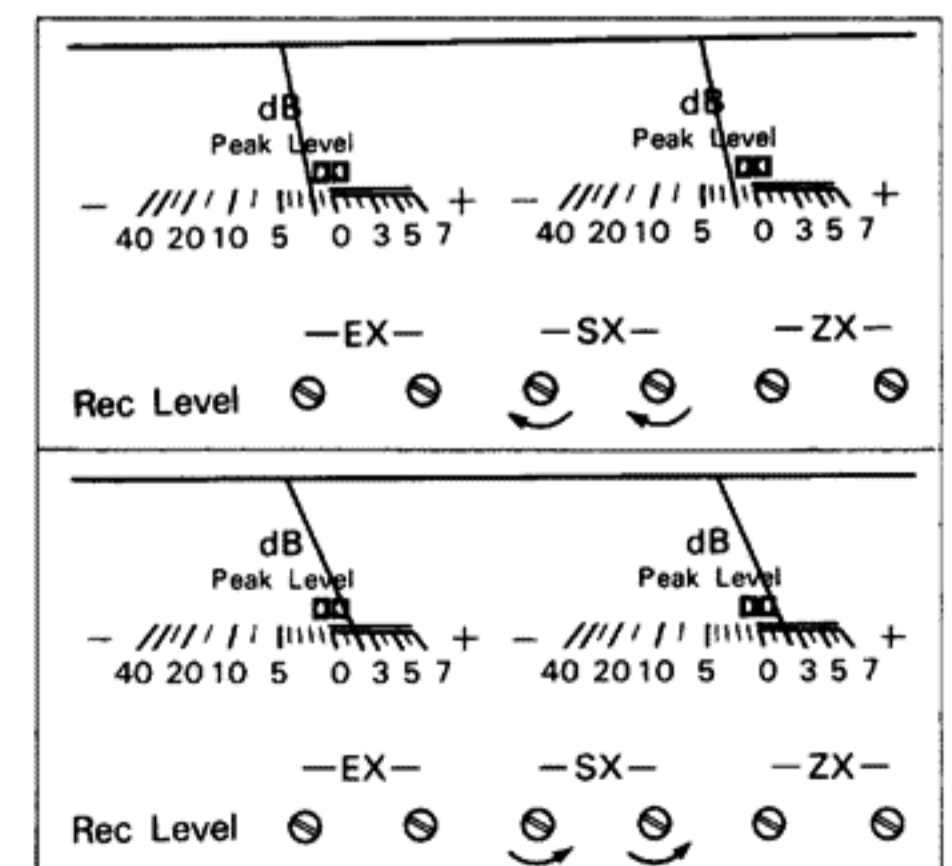

## Bias Adjustment

On page 9 of this manual, you will find a list of those cassette tapes which are compatible with the factory adjustments on your 582. There is usually no need to change bias settings as long as you continue to use one of the recommended tapes. If your recordings are not accurate reproductions of your original source material, bias adjustment may be necessary. But first look for other possible causes:

- Are the heads clean? If not, refer to page 14.
- Are the Tape and Eq selector switches properly set? (See page 9.)
- Have you checked record calibration? If not, follow the procedure described on page 11.
- Have you recently performed record head azimuth alignment? If not, refer to the enclosed Supplement.

Failure to check these points before proceeding may result in inaccurate bias adjustment, which can lead to excessive distortion and poor sound quality. Once you have ascertained that bias adjustment is necessary, carefully follow the procedure below:

- (A) As with rec cal, take a few moments to familiarize yourself with the layout of the bias adjustment screwdriver controls (23) on the front panel of the 582. There are separate controls for each of the three tape positions and for each channel.
- (B) Load the desired cassette and fast-forward for several seconds before stopping.
- (C) Set the Tape and Eq switches (21, 20) according to the type of tape in use. See page 9 for recommended settings.
- (D) Set the test tone switch (19) to "15k". This will activate the built-in 15 kHz oscillator, which now overrides any external input to the 582.

- (E) Begin recording the 15 kHz test tone by pressing the record and play buttons (7, 11) simultaneously.
- (F) Set the monitor switch (16) to "tape". The meters are now indicating the playback level of the test tone. If both meters register within one dB of the "0 dB" mark, there is no need for bias adjustment.
- (G) If the meters do not indicate 0 dB level, make adjustments to the appropriate bias controls (23) using the small screwdriver supplied with the deck. Watch the meters very closely while turning the screwdriver. If you are near the proper "bias point", you will find that the control works in a reverse manner – that is, the meter reading should decrease as you turn the control clockwise. If this is the case, simply adjust each channel for a "0 dB" reading on the appropriate meter. If you find that the meter reading increases when you turn the control clockwise, this is an indication of gross bias misadjustment, and you must follow steps (1) through (4) below.
- (H) Return the test tone switch (19) to the "off" position.

### Note:

- Even though the meters indicate "0 dB" when recording the built-in 15 kHz test tone, the actual record level is -20 dB. When you turn the test tone switch to "15 kHz", you are simultaneously increasing meter sensitivity by 20 dB. This system enables you to perform the bias adjustment more accurately by using the most convenient and precise portion of the meters' scales. This feature, however, makes it imperative that you observe step (H) above: leaving the test tone switch in the "15 kHz" position would result in grossly exaggerated meter readings during normal playback.

## Special Procedure for Correcting Gross Bias Misadjustment

This procedure should only be followed if you find that the 15 kHz level increases as you turn the appropriate bias control clockwise.

- (1) Turn the bias control clockwise until the meter reading reaches a maximum value. You will know when you have reached maximum when turning the control further clockwise produces a decrease in meter reading.
- (2) Switch the test tone to 400 Hz, and observe the meter readings. If both meters are not reading "0 dB", make the necessary rec cal adjustments. (See page 11.)
- (3) Switch back to the 15 kHz test tone. The meter readings should be above "0 dB".
- (4) Turn the bias controls further clockwise until the meter readings have decreased to "0 dB".

After you have completed this procedure, check the record calibration one more time with the 400 Hz test tone. If it is off by more than 1 dB, perform the necessary calibration. Then, repeat bias adjustment (steps (D) through (H) above).

A complete analysis of your deck's performance requires the use of sophisticated test instruments, such as the Nakamichi T-100 Audio Analyzer. Spot-check test tones, such as those built into the 582, are no substitute for professional service equipment. If you do not own a T-100 or equivalent equipment, we strongly recommend a yearly check-up at your nearest Nakamichi-authorized service center.

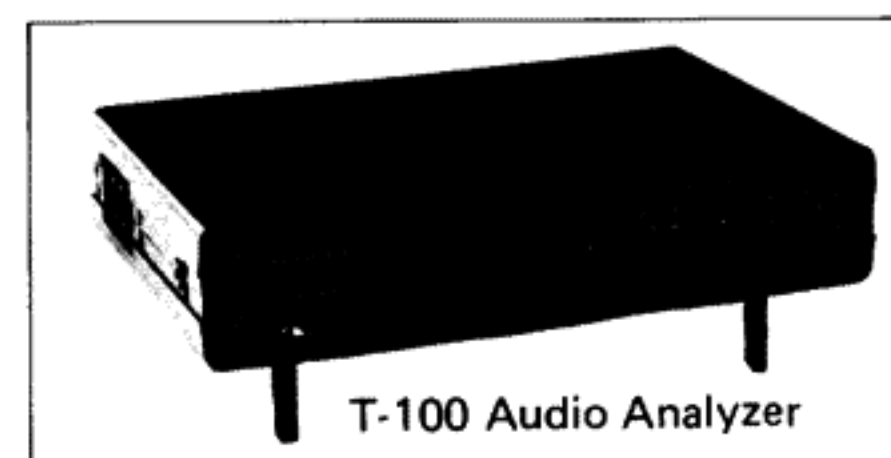

# The Dolby System

## What it will and will not do

The Dolby Noise Reduction circuits of the 582 reduce the hiss inherent in the tape recording process. The Dolby system cannot reduce the noise of your source material. If your records, FM broadcasts, microphones, and other sources are noisy, the cassette deck's Dolby system will not improve them. But the Dolby system will reduce tape noise by as much as 10 dB.

The Dolby system has an encode (record) and a decode (playback) process. Dolby-encoded cassettes should be labeled as such; when played back without the proper Dolby decoding, they will sound unnaturally "bright". Conventional (non-Dolby-encoded) cassettes will sound unnaturally "dull" when played back with Dolby decoding. This boosting and cutting of the high frequencies has much to do with how Dolby Noise Reduction is accomplished.

## How the system works

The Dolby encoder boosts the high-frequency program content before it goes onto the tape. The Dolby decoder gives the high frequencies equal and opposite treatment during playback. While the decoder returns the high-frequency content to original levels, it simultaneously reduces the high-frequency noise incurred in the recording process.

Because noise is more noticeable during quiet passages than during loud passages, the Dolby system does not treat all high frequency signals equally. It gives more of a boost to low-level high-frequency signals than it does to high-level high-frequency signals. This variation of the Dolby system's effect across the dynamic range distinguishes Dolby Noise Reduction from simply "turning up the treble" on record and "turning down the treble" on playback.

"Turning the treble" up and down is, in fact, the basic idea behind tape record and playback equalization, RIAA phono equalization, and FM pre-emphasis/de-emphasis. All of these systems involve boosting the high frequencies at one end and equal reduction of high frequencies at the other. All work to reduce noise. But the amount of boosting in each case is limited by the headroom characteristics of the medium. In the case of tape recording, too much equalization (too strong a high-frequency boost) will saturate the tape and distort the recording. Hence there is a limit to the amount of noise reduction attainable through equalization alone. FM pre-emphasis and phono equalization face similar limitations.

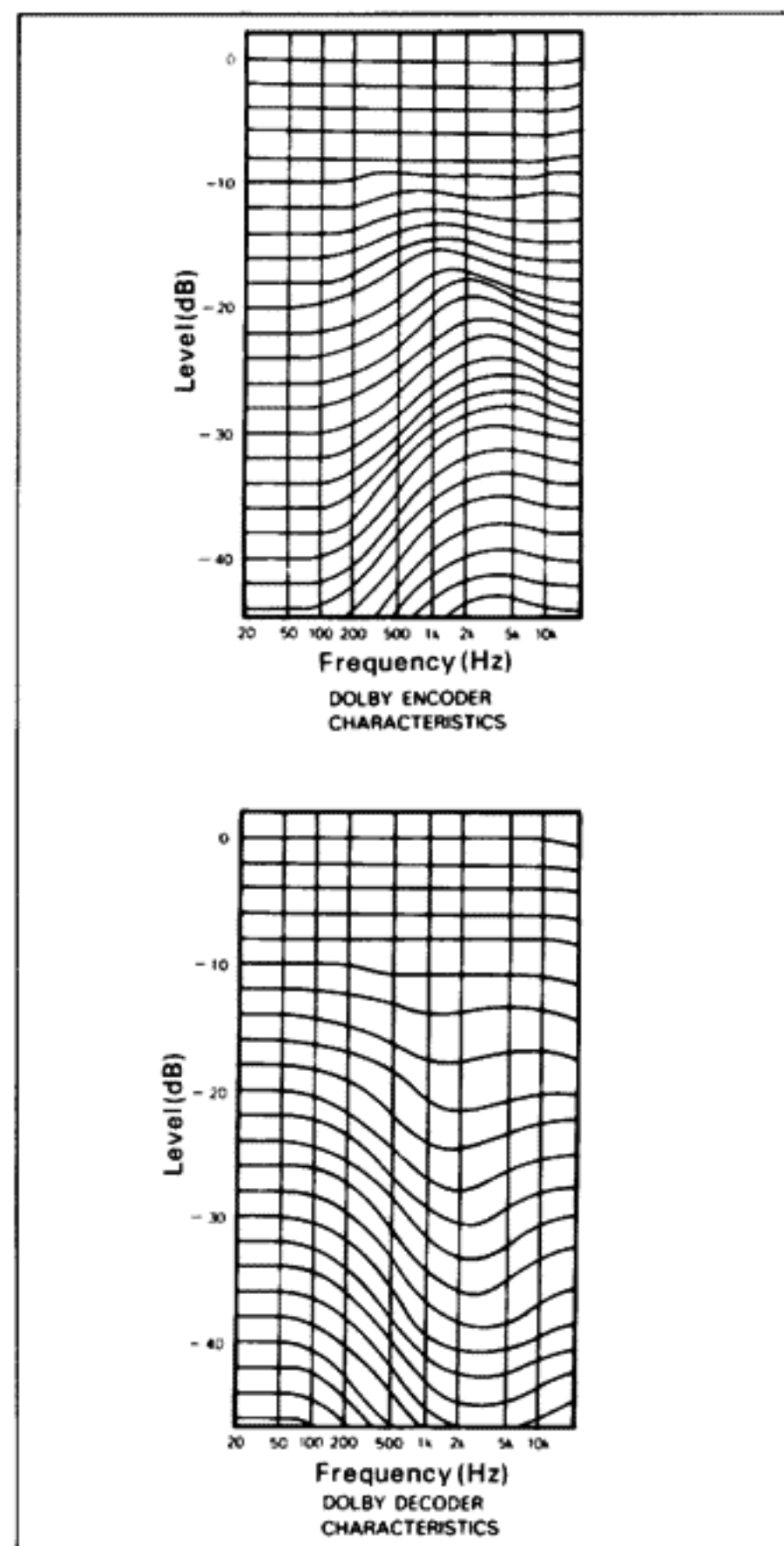

The Dolby Noise Reduction system does not, because the Dolby system only boosts low-level signals. This provides an additional 10 dB of noise reduction without threatening the headroom of the medium.

## Why is level calibration necessary?

The "rec cal" controls of the Nakamichi 582 are used in conjunction with the 400 Hz reference test tone. The adjustment assures that a tone recorded at 0 dB will play back at 0 dB. Although tape formulations of the same category (page 9) pose the same equalization requirements, variations in tape sensitivity will cause one formulation to provide more output than another formulation. The controls permit you to adjust the deck for the sensitivity of each formulation you use.

Without calibration, the Dolby circuits could potentially mis-track on different formulations. Recording on a more sensitive formulation without recalibrating would mean that a test tone recorded at 0 dB would play back at higher than 0 dB. The Dolby decoder would fail to provide the full high frequency cut, and the tape would sound slightly "bright" on playback. Conversely recording on a less sensitive tape without recalibrating would produce slightly "dull" playback. Level calibration is essential for Dolby system compatibility from cassette to cassette.

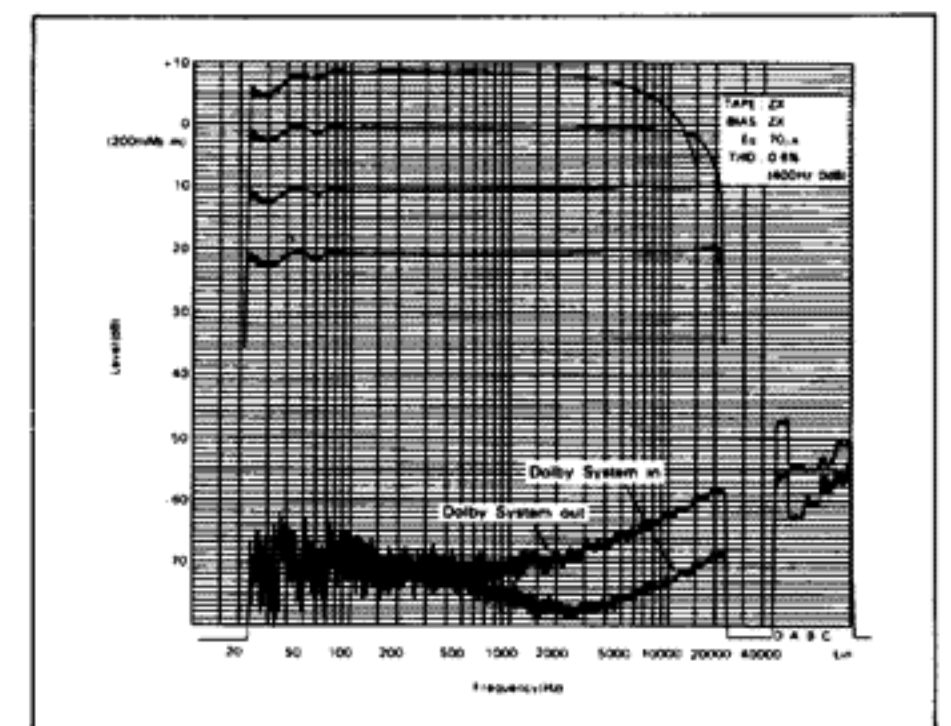



# Maintenance

## Head and Transport Cleaning

To maintain the Nakamichi 582's superior performance and to prolong the life of the heads and pressure rollers, all parts that come into contact with the tape should be cleaned frequently and thoroughly. Dirty heads, capstans or pressure rollers may result in any of the following symptoms:

- Uneven sound levels.
- Loss of high frequencies.
- Wow and flutter.
- Damage to cassette tapes.
- Tape squeal caused by excess friction.

Even the best cassettes shed particles onto the heads, capstans and pressure rollers. Clean a minimum of once every ten hours of use, even if you use premium tapes. If you must use inferior brands of tape, you may need to clean after each playing. By observing the amount of contamination accumulated on the cleaning stick pad or cotton tip, you will be able to judge whether you are cleaning the 582 frequently enough. Repeated cleanings, if properly done, will not harm the deck. Hence, it is impossible to clean too often.

A Cleaning Kit consisting of a plastic stick, sponge tips, cotton tipped sticks and a container of alcohol is supplied with your Nakamichi 582. When the alcohol runs out, use commercially available isopropyl alcohol (preferably undiluted). "Q-tips" and other cotton swabs may be used in the place of the sponge tips. Do not, however, rely on head cleaning cassettes. Some head-cleaning cassettes are unduly abrasive and may damage the heads. None of them clean the capstans and pressure rollers properly. Perform all cleaning with alcohol. Use the plastic stick with a sponge tip screwed onto its end. A cotton-tipped stick is equally effective, but be careful not to leave strands of cotton on any of the cleaned parts.

Clean in the following sequence:

- (A) Turn the power switch (15) on. Push the eject button (2) to open the cassette lid. Carefully pull the acrylic cassette compartment cover (1) out of the cassette lid. Push the cassette lid back into its well.

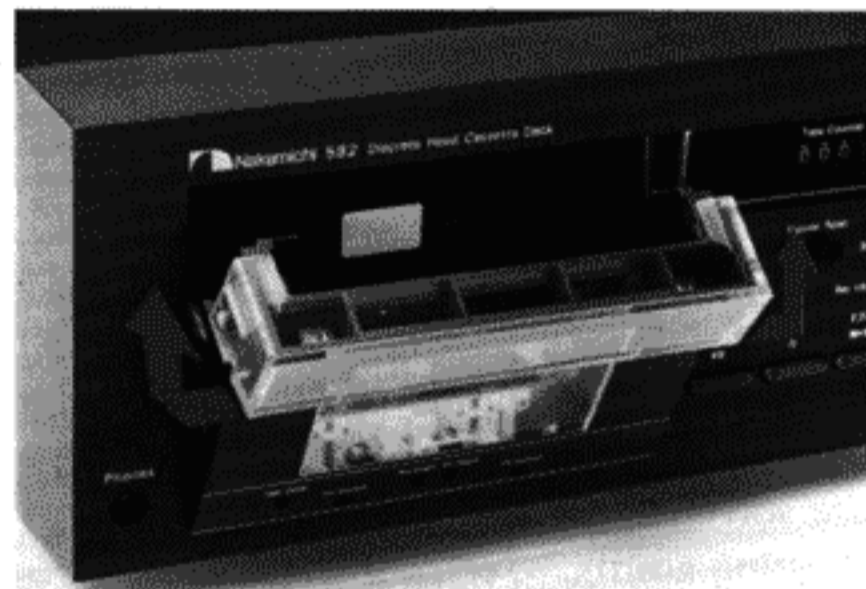

- (B) With a cleaning stick dipped in alcohol, clean the surfaces of the record/playback and erase heads. Clean with short, firm back-and-forth strokes along the path of tape travel. Also be sure to clean the tape guide on the far left.
- (C) Press the play button (11). Carefully apply the cleaning stick to one pressure roller as it turns. Use light pressure and an up-and-down stroke to cover the entire width of the roller. Repeat with the other pressure roller. If you are using a cotton-tipped stick, make sure to apply the tip to the side of the roller rotating away from the capstan; the cotton may otherwise get caught between the capstan and the roller

(if this should happen, simply press the stop button and remove the cotton).

- (D) With the transport in the stop mode, apply a clean section of the cleaning stick pad to one capstan. Move the pad up and down the capstan shaft as it turns. Repeat with the other capstan.
- (E) Press the eject button, and carefully re-insert the acrylic cover.

Cleaning is now completed, but give the cleaned surfaces a minute or two to dry off completely before playing a tape.

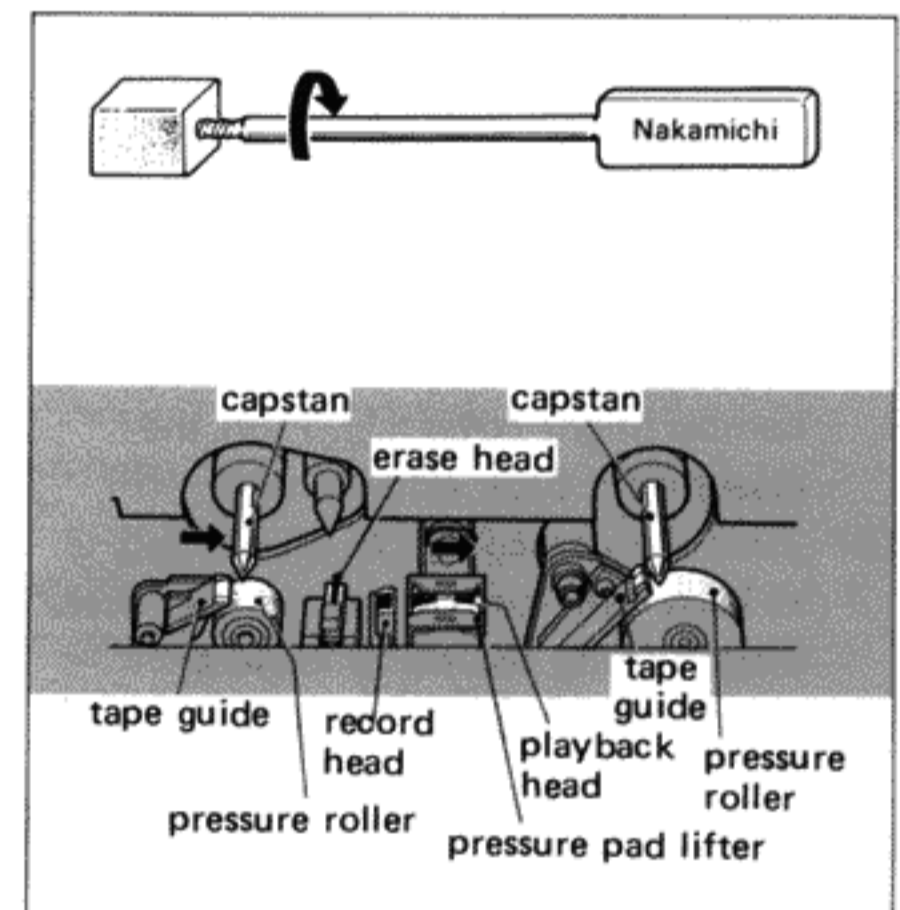

### CAUTION:

- Tape guide and heads are critically aligned at the factory. Do not exert too much pressure on these parts. It is better to stroke repeatedly than to stroke forcefully.
- Do not flood various parts with cleaning alcohol. After dipping the stick into alcohol, squeeze off any excess.
- Be sure to remove any cotton strands from the cleaned parts.

## Demagnetizing

All metal parts that come into contact with the tape must be occasionally demagnetized to prevent the build-up of residual magnetism. Such magnetism can add hiss to a tape being played and partially erase the high frequencies. Although the heads and capstans of Nakamichi cassette decks require demagnetizing less frequently than those of most other cassette decks, you should nevertheless demagnetize once every 50 hours of use to be on the safe side. The Nakamichi DM-10 Demagnetizer is recommended since it has been specifically designed for cassette decks, but any properly designed demagnetizer will do.

- (A) Remove all tape from the vicinity of the tape deck before proceeding. Make sure the 582's power switch (15) is off. Remove the cassette compartment cover (1). Push the cassette lid back into its well.
- (B) Turn the demagnetizer on while it is at least two feet away from the deck. Slowly bring the tip as close as possible to the playback head. Do not make contact with the head unless the tip of the demagnetizer is covered with vinyl or rubber to prevent scratching the head's surface. A piece of vinyl tape may be used to cover the tip if it is not already covered.
- (C) Move the demagnetizer slowly in a random pattern about the surface of the head for at least 10 seconds. Move it slowly to the record head and repeat the random pattern. Then, move the demagnetizer to one capstan then the other, repeating the random pattern for 10 seconds. (It is not necessary to demagnetize the erase head.)
- (D) After demagnetizing the capstans, slowly withdraw the demagnetizer from the deck. Wait until the

demagnetizer is at least two feet from the deck before turning the demagnetizer off. Never turn it off while it is close to a head or capstan as this may semi-permanently magnetize the part.

## Lubrication

The moving parts of the Nakamichi 582 transport are fitted with oil-less bearings. Periodic lubrication is not necessary.

## Cleaning the Faceplate

Remove dust or smudges with diluted detergent applied with a soft-cloth. Never use solvents, ammonia, or abrasive cleaning agents.

## Head Height and Azimuth

The head height and azimuth adjustments of the Nakamichi 582 are calibrated at the factory for optimum performance. Readjustment should only be done by qualified service technicians. The only exception to this is record head azimuth. See the enclosed supplement.

## Repairs

Your Nakamichi 582 has been designed for long service life. Should your 582 require servicing, please consult your Nakamichi dealer or the Nakamichi dealer nearest you. As there are no user-serviceable parts inside the unit, please do not attempt your own repairs.

# Troubleshooting

	Probable Cause	Remedy
Tape does not run.	<ol style="list-style-type: none"><li>1. Power cord is unplugged.</li><li>2. Tape is loose inside cassette.</li><li>3. Cassette is not properly seated.</li></ol>	<p>Plug in cord firmly. Wind tape up. Eject and re-insert cassette.</p>
Cannot record.	<ol style="list-style-type: none"><li>1. Input disconnected.</li><li>2. Head dirty.</li><li>3. Cassette tabs have been removed.</li></ol>	<p>Check connections. Clean head. Place adhesive tape over tab opening or use new cassette.</p>
Cannot playback.	<ol style="list-style-type: none"><li>1. Output disconnected.</li><li>2. Dirty head.</li></ol>	<p>Check connections. Clean head.</p>
Excessive playback hiss.	<ol style="list-style-type: none"><li>1. Head is magnetized.</li><li>2. Recording volume is too low.</li></ol>	<p>Demagnetize head. Adjust recording levels.</p>
Distorted playback.	<ol style="list-style-type: none"><li>1. Program material is itself distorted.</li><li>2. Recording levels are too high.</li></ol>	<p>Check program material. Adjust recording levels.</p>
Unsteady tape travel.	<ol style="list-style-type: none"><li>1. Capstan and/or pressure roller dirty.</li><li>2. Tape packing inside cassette faulty.</li></ol>	<p>Clean these parts. Replace cassette.</p>
Incomplete erasure.	Erase head is dirty.	Clean head.
Weak high frequencies.	<ol style="list-style-type: none"><li>1. Dirty heads.</li><li>2. Magnetized head.</li><li>3. Improper bias level for tape.</li></ol>	<p>Clean heads. Demagnetize head. See section on Bias Adjustment.</p>
Hum heard during record or playback.	<ol style="list-style-type: none"><li>1. Induction fields near deck.</li><li>2. Signal cable grounding faulty.</li></ol>	<p>Keep deck away from amplifier, transformers, fluorescent lamps, etc. Replace signal cables.</p>

# Specifications

## Specifications:

Power Source .....	100, 120, 120/220-240, 220 or 240V; 50/60Hz
Power Consumption .....	27W Max.
Tape Speed .....	1-7/8 ips. (4.8 cm/sec.) ±0.5%
Wow and Flutter .....	Less than 0.1% WTD Peak, 0.05% WTD rms
Frequency Response .....	20-20,000 Hz ±3 dB (-20 dB Rec. Level)
Signal to Noise Ratio .....	Better than 60 dB at 400 Hz, 0 dB, WTD rms
(Dolby NR In, 70µs)	Better than 66 dB at 400 Hz, 3% THD, WTD rms
Total Harmonic Distortion .....	Less than 0.8% at 400 Hz, 0 dB (ZX Tape)
	Less than 1.0% at 400 Hz, 0 dB (SX, EXII Tapes)
Erase .....	Better than 60 dB below saturation level at 1 kHz
Separation .....	Better than 37 dB at 1 kHz, 0 dB
Crosstalk .....	Better than 60 dB at 1 kHz, 0 dB
Bias Frequency .....	105 kHz
Input .....	50 mV, 50 k ohms
Output Level .....	1V (400 Hz, 0 dB, Output Level at Max.) 2.2k ohms
Headphone .....	45 mW
DC Output Jack .....	±10V 125mA Max.
Dimensions .....	500(W) x 130(H) x 350(D) m/m
	19-11/16(W) x 5-1/8(H) x 13-25/32(D) inches
Approximate Weight .....	8.3 kg, 18 lb 5 oz

- Specifications and appearance design are subject to change for further improvement without notice.
- Dolby NR under license from Dolby Laboratories.
- The word "DOLBY" and the Double-D-Symbol are trademarks of Dolby Laboratories.

## Optional Accessories

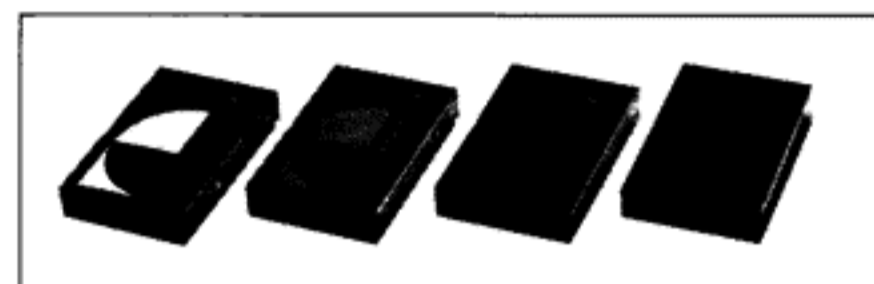

ZX Cassette Tape C-60, C-90  
 SX Cassette Tape C-60, C-90  
 EXII Cassette Tape C-60, C-90  
 EX Cassette Tape C-60, C-90



Head Demagnetizer

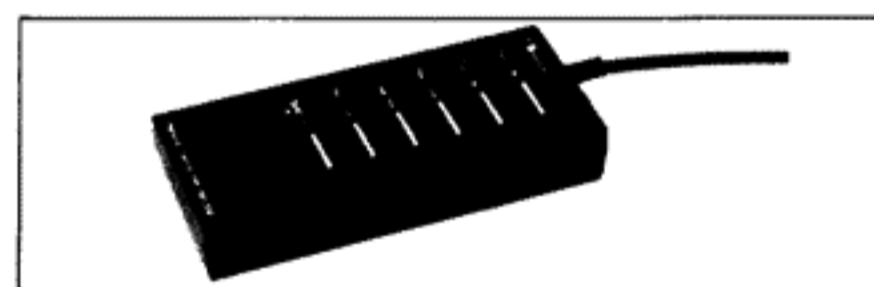

RM-200 Remote Control



MX-100 Microphone Mixer



SF-100 Subsonic Filter

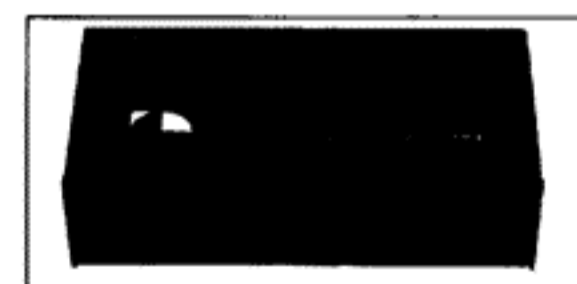

LA-100 Line Amplifier

**Nakamichi Corporation**  
 1-153 Suzukicho, Kodaira, Tokyo  
 Phone: (0423) 42-1111  
 Telex: 2832610 (NAKAM J)  
 Cable: NAKAMICHI KOKUBUNJI

**Nakamichi U.S.A. Corporation**  
 220 Westbury Avenue  
 Carle Place, N.Y. 11514  
 Phone: (516) 333-5440  
 Telex: 144513 (NAKREI CAPL)

**Nakamichi U.S.A. Corporation**  
 1101 Colorado Avenue  
 Santa Monica, Calif. 90401  
 Phone: (213) 451-5901  
 Telex: 652429 (NAKREI SNM)